

POWERHOUSE HOME GYM PLATE/STACK LOADING

*MODEL # phc1300pl/phc1300st
Assembly instructions, Illustrations & Parts List*

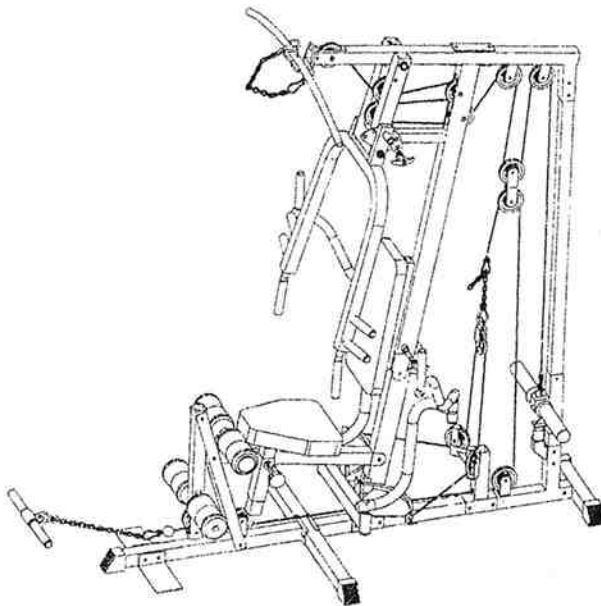

PHC1300PL

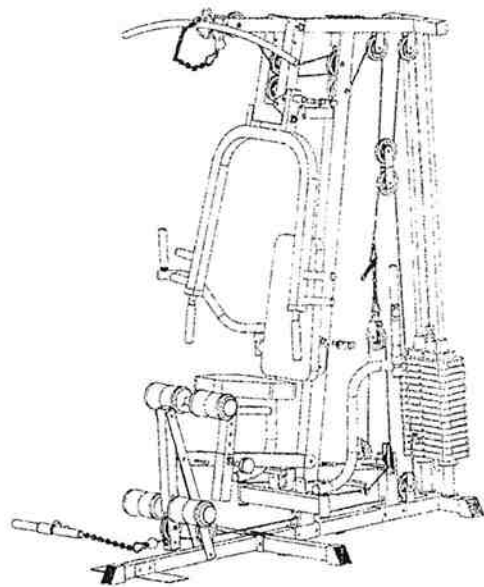

PHC1300ST

PHC1300ST HARDWARE ILLUSTRATION



D9: LOWER CABLEX1PC(140")



D10: UPPER CABLEX1PC(156")



D8: BUTTERFLY CABLEX1PC(87")



D5: 1/2" PULLEY BUSHINGX2PCS



D1: NYLON BUSHINGX10PCS



D2: 1/4" BUSHINGX2PCS



D3: 1/2" BUSHINGX2PCS



D4: 5/8" PULLEY BUSHINGX10PCS



D20: 45 SQ INNER PLUG X2PCS



D21: 50 SQ NYLON INNER PLUG X1PC



D22: 50 SQ INNER PLUG X7PCS

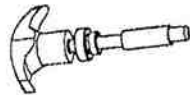

D32: LONG PULL PIN X2PCS

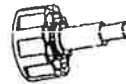

D33: LOCK KNOB X1PC



D23: 25X50 SQ INNER PLUG X6PCS



D12: L-SHAPED BRACKET X3PCS



D34: ARM CURL HANDLE X1PC



D17: 125 GRIPX6PCS

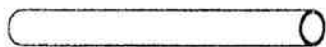

D19: LAT BAR GRIPX2PCS



D18: 160 GRIPX4PCS

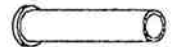

D28: SWIVEL SLEEVE X2PCS

PHC1300ST HARDWARE ILLUSTRATION



D30:45 SQ SLEEVE X2PCS



D29:50 SQ SLEEVE X2PCS



D24:D25 INNER PLUG X4PCS



D25:D32 INNER PLUG X4PCS

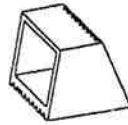

D27:50 SQ END CAP X5PCS



D26:D38 INNER PLUG X2PCS



D36:RUBBER STOPPER X1PC

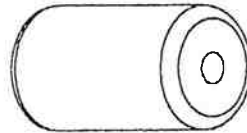

D35:FOAM ROLL X4PCS



D38:RUBBER BUMPER BRACKET X2PCS



D15:LONG CHAIN X2PCS



D16:SHORT CHAIN X1PC

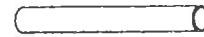

D7:7" AXLE X1PC



D13:SPRING CLIP X2PCS



D11:PULLEY X15 PCS



D14:D7 C-CLIP X7 PCS



D31:OLYMPIC SLEEVE X2PCS

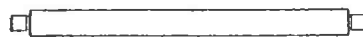

D6:M12 AXLE X1PC



D39:P-PIN X1PC

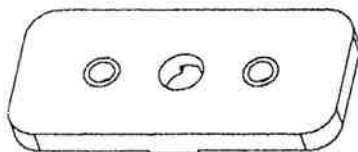

D40:WEIGHT PLATE X15PCS



D37:RUBBER BUMPER X2PCS

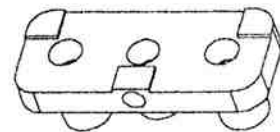

D41:SELECTOR STEM X1PC

PHC1300ST HARDWARE ILLUSTRATION



A4: CARRIAGE BOLT M10X90X2PCS

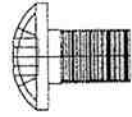

A5: ALLEN BOLT M10X15X2PCS

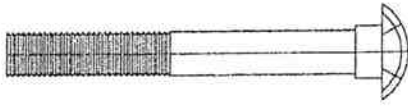

A3 CARRIAGE BOLT M10X70X13PCS

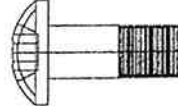

A16: ALLEN BOLT M10X25X4PCS

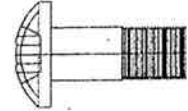

A6: ALLEN BOLT M10X25X2PCS (HALF THREAD)



A15: ALLEN BOLT M8X40X4PCS



A1: SLOTTED SET SCREW M6X8X4PCS

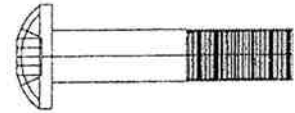

A7 ALLEN BOLT M10X45X9PCS

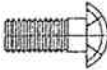

A2: PHILIPS SCREW M6X15X1PC

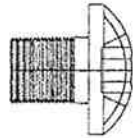

A14 ALLEN BOLT M12X15X4PCS



A8: ALLEN BOLT M10X60X1PC

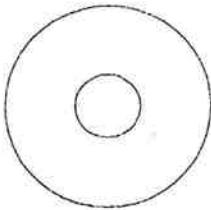

C3: WASHER D12XD38X2.5TX4PCS

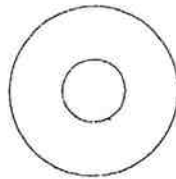

C4: WASHER D12XD32X2.5TX2PCS



A9: ALLEN BOLT M10X65X3PCS



A10: ALLEN BOLT M10X70X1PC

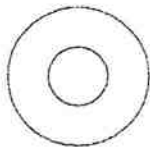

C2: WASHER D10XD25X1.5TX47PCS

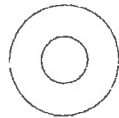

C1: WASHER D8XD20X1.5TX4PCS



A11: ALLEN BOLT M10X90X1PC



B1: AIRCRAFT NUT M10X31PCS

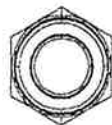

B2: AIRCRAFT NUT M12X2PCS



A12 ALLEN BOLT M10X100X2PCS



A13 ALLEN BOLT M10X170X1PC

PHC1300ST PARTS ILLUSTRATION

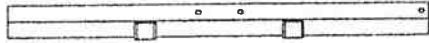

O:FRONT STABILIZER X1PC



P:FRONT SUPPORT FRAME X2PCS



Q:LAT BAR X1PC



R:LEG DEVELOPER X1PC

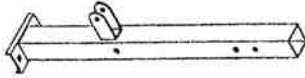

S:FRONT BASE X1PC



T:GOD SLEEVE X2PCS

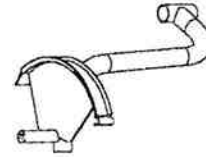

U: BUTTERFLY X1PAIR

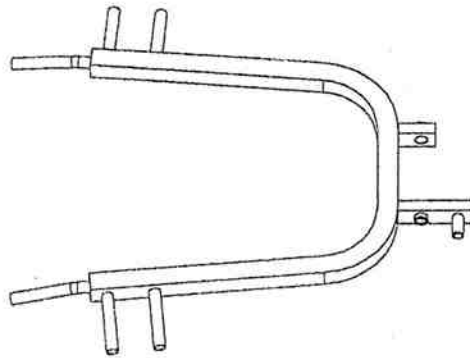

V:FRONT PRESS X1PC

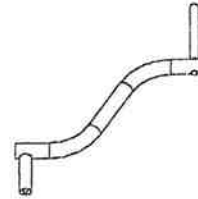

W: BUTTERFLY HANDLE X2PCS

Y:SHORT BRACKET X1PC

AA:SINGLE PULLEY BRACKET X1PC



X:LONG BRACKET X1PC

Z:DOUBLE PULLEY BRACKET X1PC



AB:GUIDE ROD X2PCS

PHC1300ST PARTS ILLUSTRATION



A: UPPER FRAME X1PC



B: SEAT POST X1PC

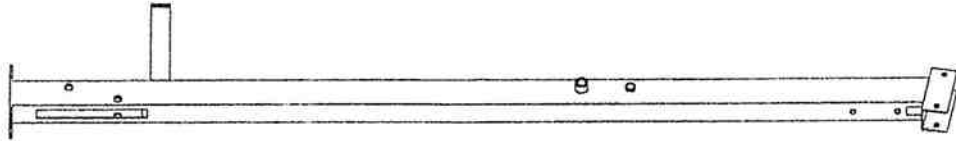

C: VERTICAL BEAM X1PC

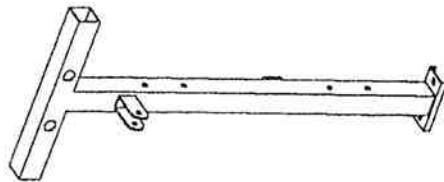

D: MAIN BASE FRAME X1PC

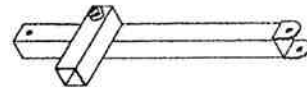

E: SEAT SUPPORT X1PC

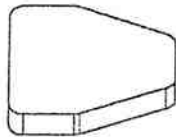

F: SEAT PAD X1PC

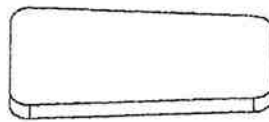

G: BACKREST BOARD X1PC

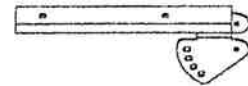

H: BACKREST SUPPORT X1PC



I: SELECTOR BAR X1PC

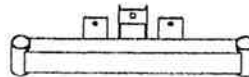

J: BUTTERFLY BASE X1PC

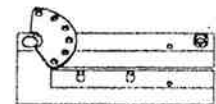

K: FRONT PREE BASE X1PC

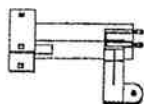

L: BUTTERFLY PULLEY BRACKET X1PC



M: FOAM ROLL & ARM HANDLE TUBE X3PCS



N: FOOT PLATE X2PCS

PHC1300PL ASSEMBLY-STEP1

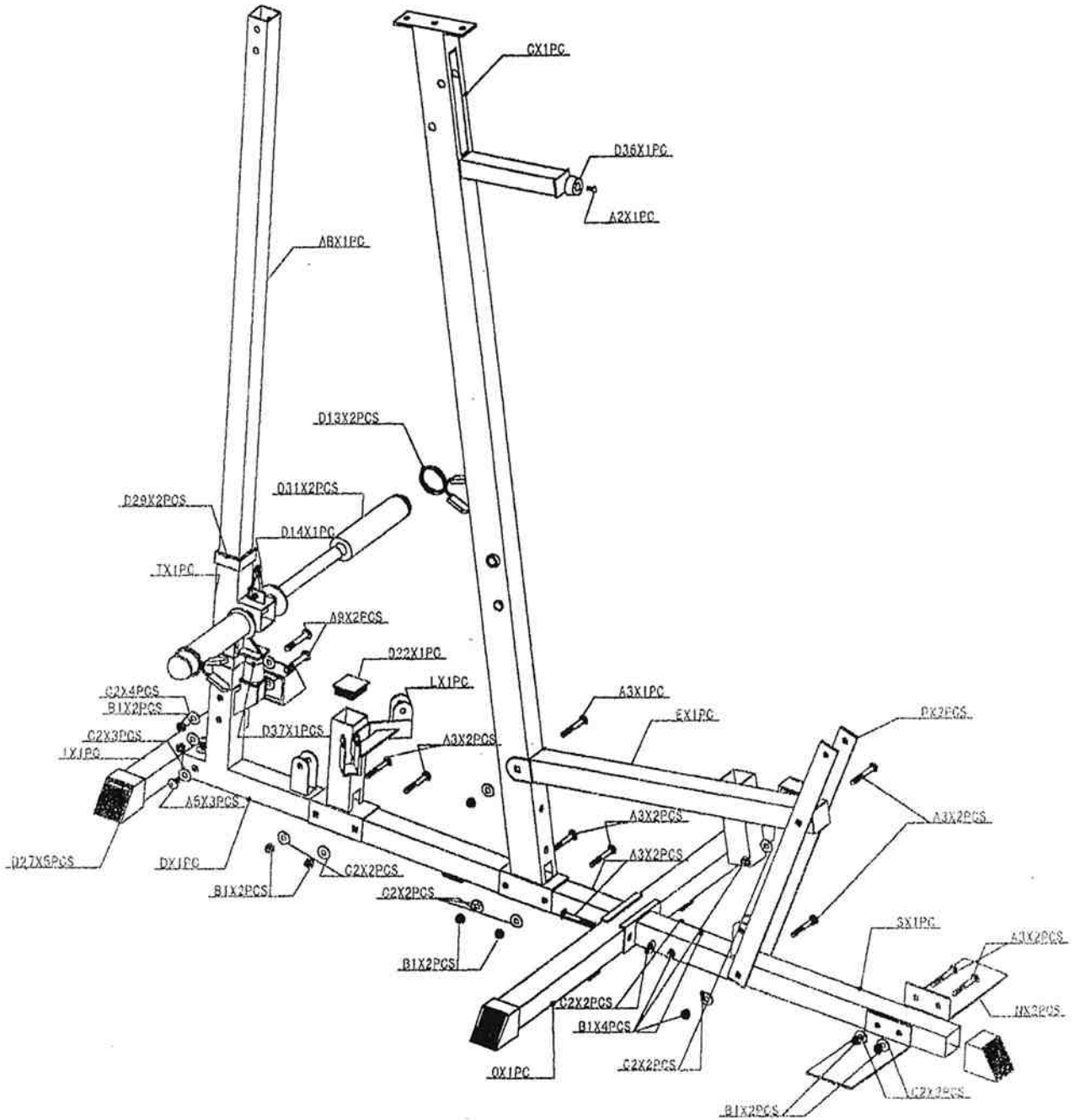

PHC1300PL ASSEMBLY-STEP2

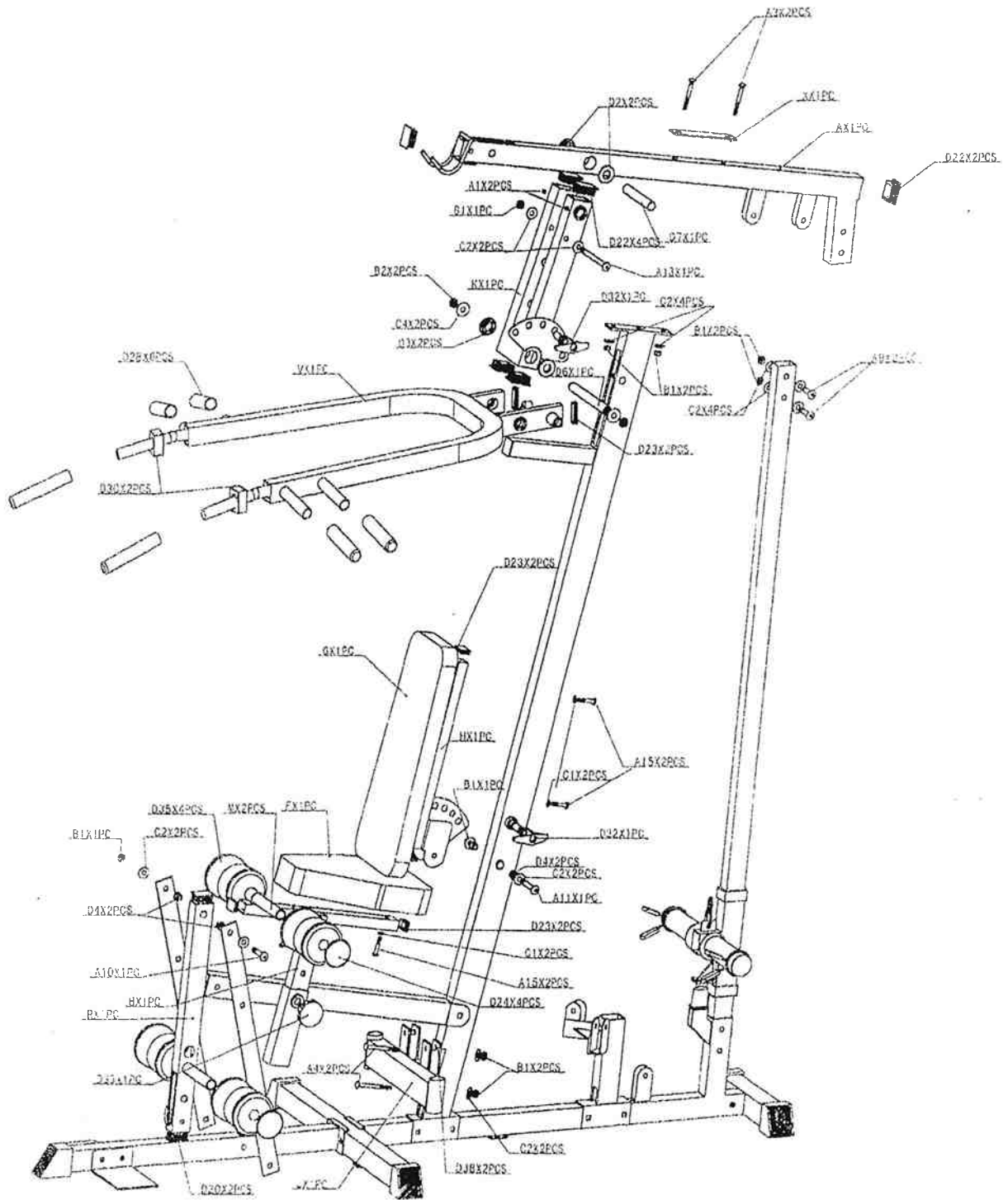

PHC1300PL ASSEMBLY-STEP3

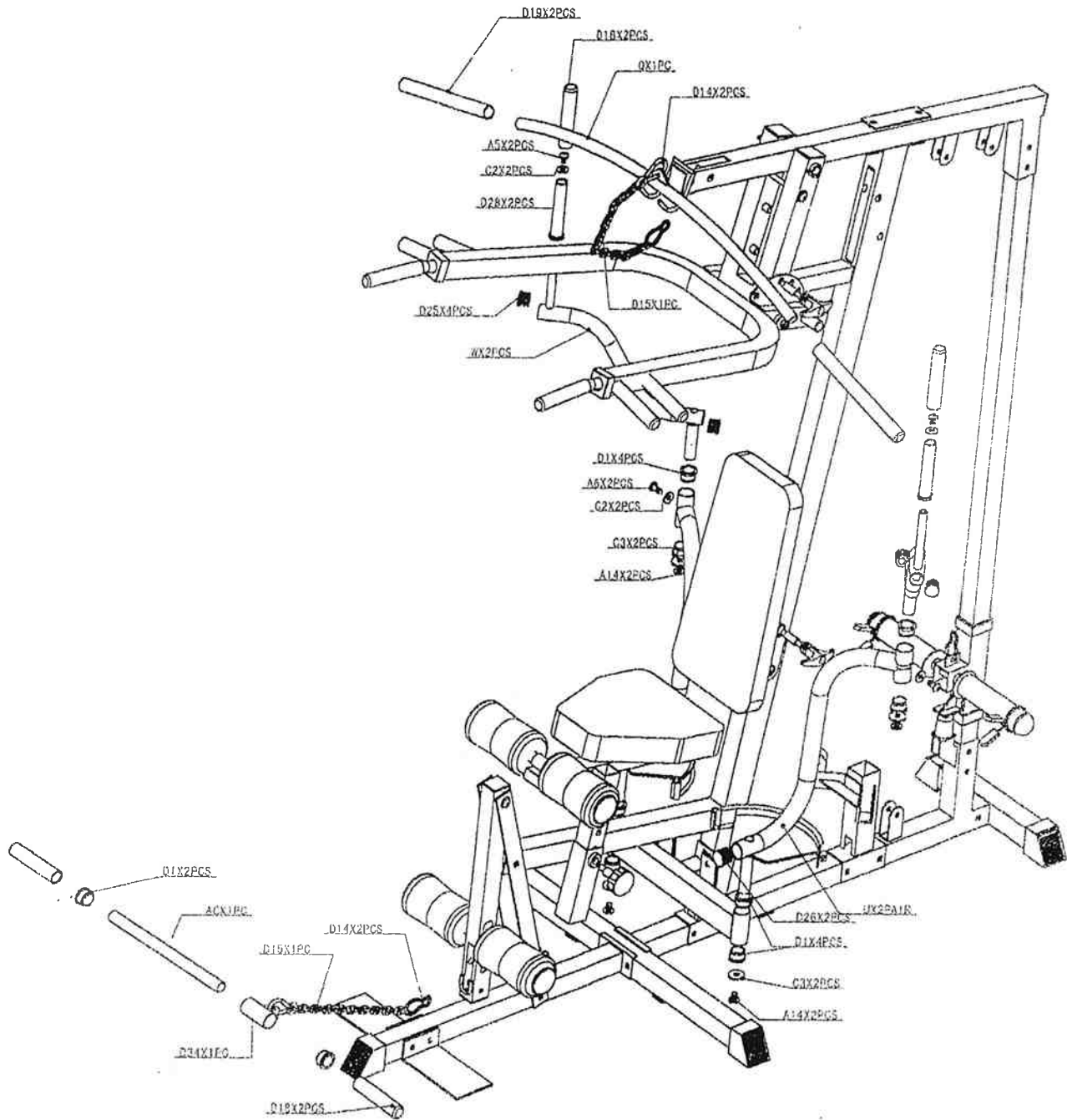

PHC1300PL ASSEMBLY-STEP4

